

CIC-14 REPORT COLLECTION  
**REPRODUCTION**  
**COPY**

LA-2287

*C83*

**LOS ALAMOS SCIENTIFIC LABORATORY**  
**OF THE UNIVERSITY OF CALIFORNIA ○ LOS ALAMOS NEW MEXICO**

---

**THE ETCHING OF PLUTONIUM AND ITS ALLOYS**  
**BY CATHODIC BOMBARDMENT**

LOS ALAMOS NATIONAL LABORATORY  
  
3 9338 00320 7890

### LEGAL NOTICE

This report was prepared as an account of Government sponsored work. Neither the United States, nor the Commission, nor any person acting on behalf of the Commission:

A. Makes any warranty or representation, express or implied, with respect to the accuracy, completeness, or usefulness of the information contained in this report, or that the use of any information, apparatus, method, or process disclosed in this report may not infringe privately owned rights; or

B. Assumes any liabilities with respect to the use of, or for damages resulting from the use of any information, apparatus, method, or process disclosed in this report.

As used in the above, "person acting on behalf of the Commission" includes any employee or contractor of the Commission to the extent that such employee or contractor prepares, handles or distributes, or provides access to, any information pursuant to his employment or contract with the Commission.

Printed in USA. Price \$1.25. Available from the  
Office of Technical Services  
U. S. Department of Commerce  
Washington 25, D. C.

LA-2287  
METALLURGY AND CERAMICS  
(TID-4500, 14th edition)

**LOS ALAMOS SCIENTIFIC LABORATORY**  
**OF THE UNIVERSITY OF CALIFORNIA LOS ALAMOS NEW MEXICO**

---

REPORT WRITTEN: January 6, 1959

REPORT DISTRIBUTED: April 22, 1959

**THE ETCHING OF PLUTONIUM AND ITS ALLOYS**  
**BY CATHODIC BOMBARDMENT**

by  
Katherine Imlah

This report expresses the opinions of the author or authors and does not necessarily reflect the opinions or views of the Los Alamos Scientific Laboratory.



Contract W-7405-ENG. 36 with the U. S. Atomic Energy Commission



## ABSTRACT

The development of microstructural detail by cathodic bombardment has been used successfully for many metals and alloys which are difficult to etch by conventional methods. An application of this technique to plutonium and its alloys is presented here. A method for preventing the specimen from overheating is included in the description of the equipment. Photomicrographs of a few clean, well defined microstructures obtained by cathodic bombardment of plutonium and some of its alloys are also included, together with photomicrographs of the same specimens etched by means of conventional techniques.

## ACKNOWLEDGMENT

The author gratefully acknowledges the assistance of W. N. Miner in editing this report.

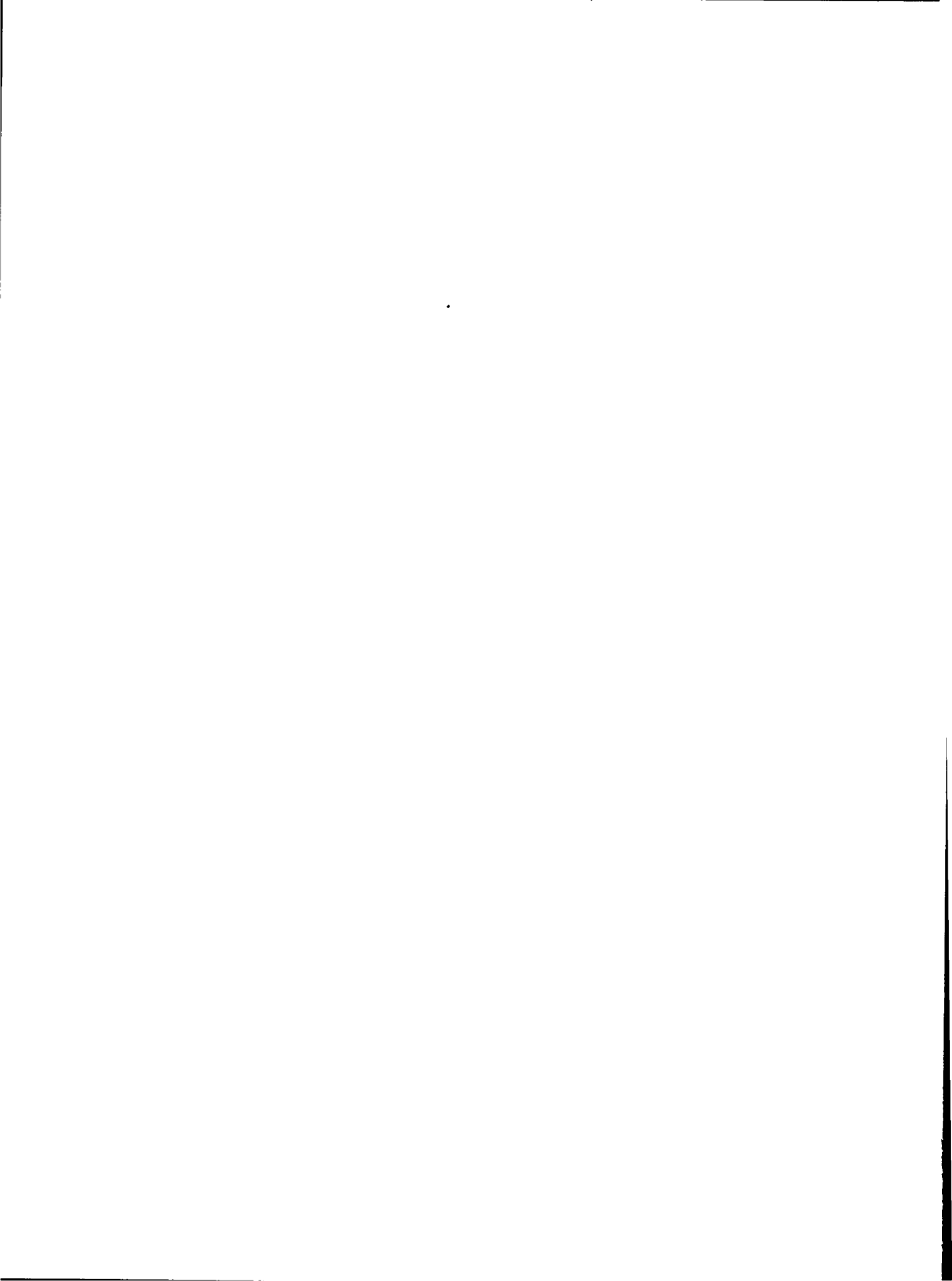

## INTRODUCTION

The etching of plutonium and its alloys by electrochemical methods<sup>1</sup> to develop a suitable structure for microscopic examination does not always give satisfactory results. E. M. Cramer and F. W. Schonfeld<sup>2</sup> have described an etching technique dependent on an electrolytic polish-etch that produces microstructural detail suitable for the study of many plutonium alloys, but frequently this method is too selective for a multiphase structure, or is ineffective, as for the alpha plutonium allotrope. The need for a technique more adaptable to hot cell application than wet chemical methods, an increase in the variety of plutonium alloys to be examined, and the necessity for simultaneously studying specimens of plutonium fuel alloys and container materials all added impetus to the investigation of cathodic etching.

A technique for etching specimens for metallographic examination by means of cathodic disintegration appeared in the literature as early as 1927.<sup>3</sup> This method depends on the preferential removal of metal atoms from grain boundaries or other areas of high energy by bombardment of a polished specimen surface with positive gas ions accelerated by an induced potential. The successful use of ionic bombardment to reveal microstructural detail of uranium by T. R. Padden and F. Cain,<sup>4</sup> T. K. Bierlein,<sup>5</sup> and K. Imlah<sup>6</sup> suggested the possibility that this method might be used to develop hitherto unobtainable microstructures of plutonium alloys. The effective use of ionic bombardment to achieve

etching requires a chamber that can be evacuated and backfilled to low pressure with an inert gas such as argon; a simple anode; a cathode, which also acts as the specimen support; and a power supply that can be controlled to apply high voltage, in the range of a few kilovolts, at low amperage.

#### EQUIPMENT

The equipment consisted essentially of an aluminum base plate or cathode, an aluminum anode suspended above the cathode, a Pyrex chimney to confine the electrical discharge to the center of the cathode, a small bell jar to enclose the etching chamber, and external vacuum and power supply systems. Aluminum was selected as the electrode material because of its relatively low sputtering rate,<sup>7</sup> its ease of fabrication, and its high thermal conductivity.

Because etching of plutonium was the ultimate aim and because the nature of the sputtered plutonium deposit was not known, it was decided to enclose the etching chamber in a glovebox. In the event that the deposit should prove to be highly pyrophoric, the box was provided with a gas inlet so that it could be flooded with helium to control any possible burning. Details of the confinement of alpha activity to a glovebox have been described in the literature.<sup>8</sup>

Figure 1 is a schematic drawing of the glow discharge chamber as installed in the glovebox and connected to the power, water, inert gas, and vacuum lines. The aluminum cathode base plate, 6 in. in diameter,



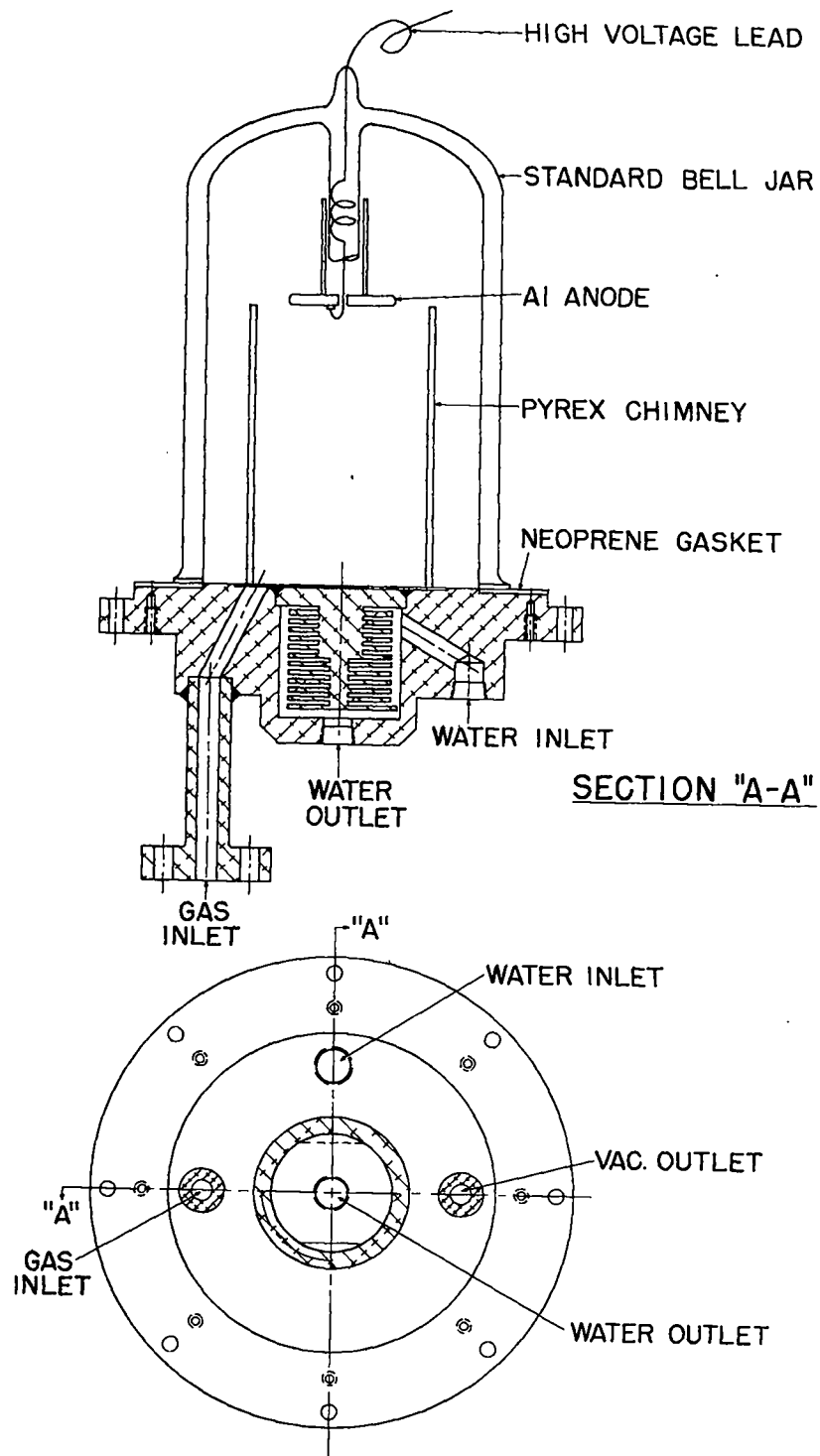

Fig. 1 Schematic diagram of glow discharge chamber.

was grooved to position the bell jar, focusing chimney, and a rubber "O" ring, which served as a vacuum seal between the bell jar and base plate. The cathode had a 2 in. diameter central cavity, extending to within 1/16 in. of its top surface, through which cold tap water was circulated to remove the heat generated in the specimen during bombardment. Adjacent to this water-cooled area were two 3/8 in. diameter holes, extending through the base plate, for vacuum outlet and gas inlet. The base plate was permanently connected to the bottom of the glovebox and was sealed to it with rubber "O" rings to ensure containment of any alpha-active particles.

A removable Pyrex focusing chimney, 3 in. in diameter by 6 in. long, was used to confine the electrical discharge and to collect the metal atoms that were removed from the specimen.

The flexible wire, high voltage lead was brought into the chamber through a glass-to-metal seal centered in the top of the bell jar and was bolted to the anode. The anode, an aluminum disk 2 in. in diameter by 1/4 in. thick, was suspended from a glass projection in the top of the bell jar so that it could be positioned about 4 in. above the center of the cathode. Teflon shields insulated the cathode and the back of the anode to eliminate arcing outside the focusing chimney. Good electrical and thermal contact between the specimen (and its aluminum mount) and the cathode was obtained by using a low-melting metal, gallium, as the coupling medium. The specimen mount was an aluminum cylinder, 1-1/4 in. in diameter by 1/2 in. thick, recessed to contain the specimen. A

polymerized liquid casting resin was used to hold the specimen in place in the mount and the recessed surface was wet with gallium to ensure good contact between the specimen and the mount.

Figures 2 and 3 illustrate the vacuum system and power supply that were designed and built by LASL Group CMB-7 as portable units and were external to the glovebox. A bottle of argon gas, mounted on the vacuum unit, was connected to one of the ports in the cathode by means of a pressure-reducing valve and a variable leak valve. The leak valve, shown schematically in Fig. 4, was designed with a long tapered seat to provide a large seat area for sensitive control of the leak rate. In order to maximize the number and velocity of ions reaching the specimen surface, argon was selected to be the ionizing gas. Argon has a high cathode fall of potential when aluminum is the cathode metal.<sup>9</sup>

#### PROCEDURE

Uranium was first etched in the chamber as a stand-in for plutonium. When the operating conditions had been established for uranium, alpha plutonium was substituted. Prior to etching, the specimen was placed in the aluminum mount, and the recess, which had been coated with gallium, was filled with a polymerized liquid casting resin to hold the specimen firmly in place. Then, conventional mechanical methods were used to polish the specimen, final polishing being accomplished with a 1/4 micron diamond lap.

Nos. 1,2,3,4,5,6 — VECCO VALVES

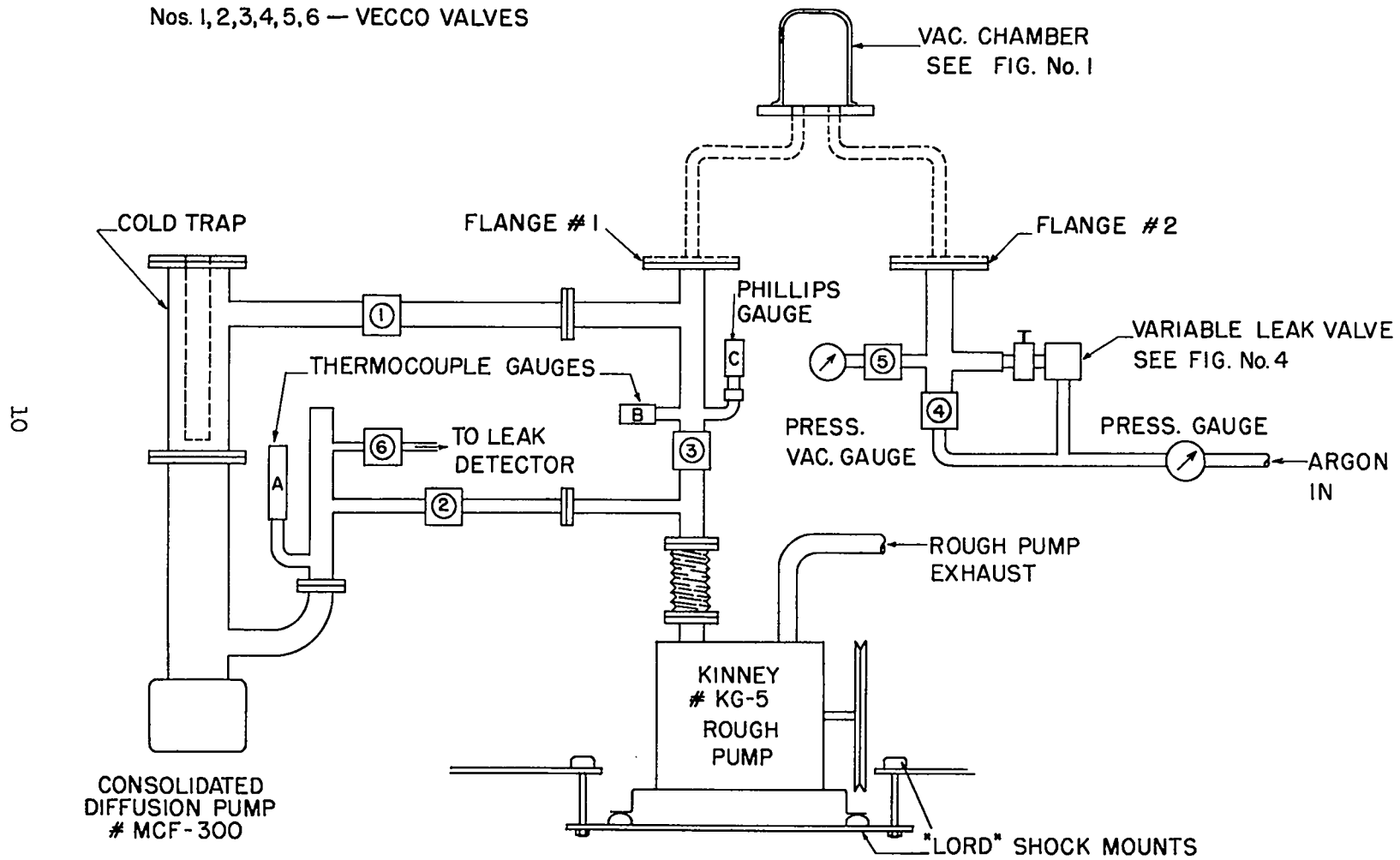
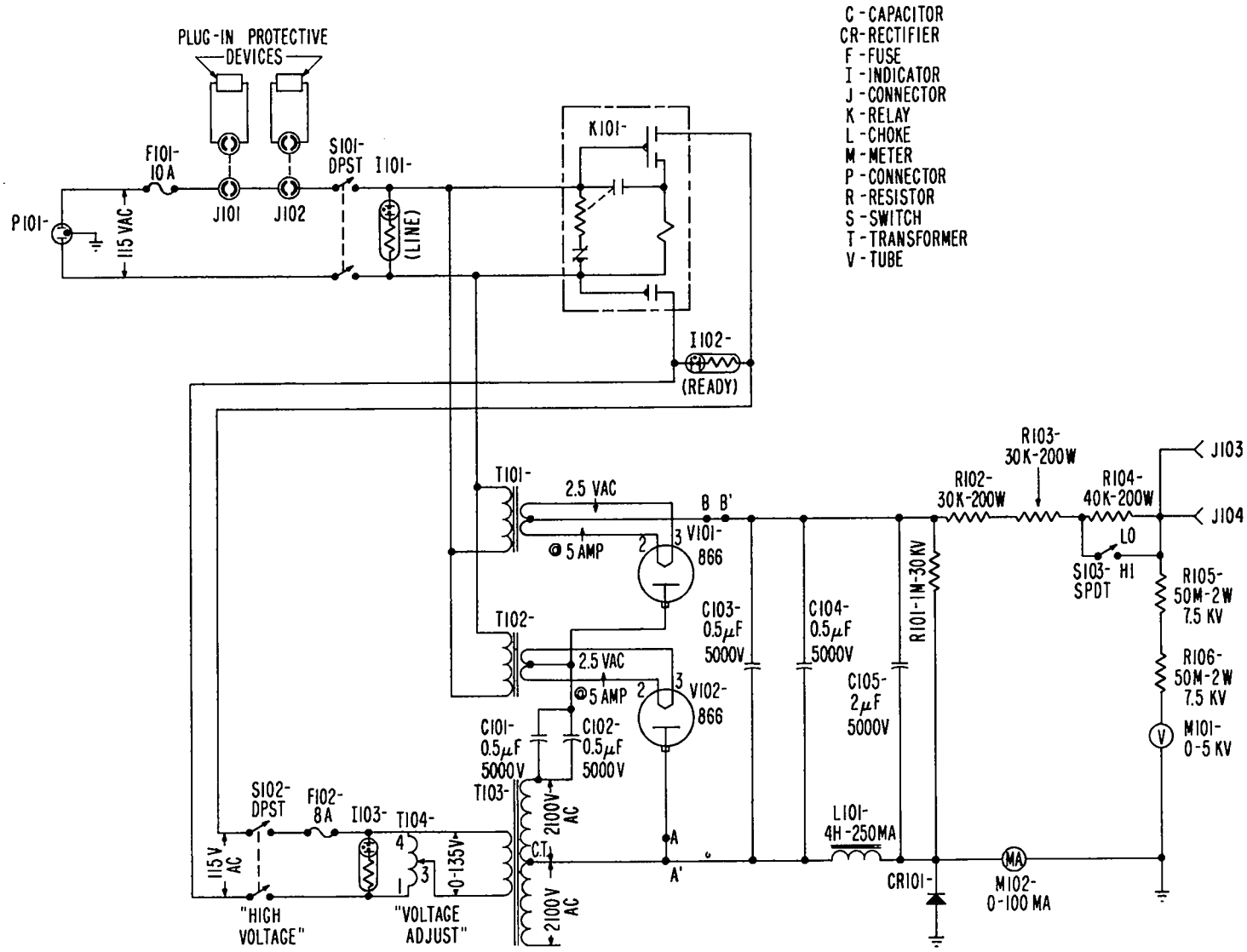

Fig. 2. Schematic diagram of vacuum system.

11



- C - CAPACITOR
- CR - RECTIFIER
- F - FUSE
- I - INDICATOR
- J - CONNECTOR
- K - RELAY
- L - CHOKE
- M - METER
- P - CONNECTOR
- R - RESISTOR
- S - SWITCH
- T - TRANSFORMER
- V - TUBE

Fig. 3. Wiring diagram of high voltage power supply.

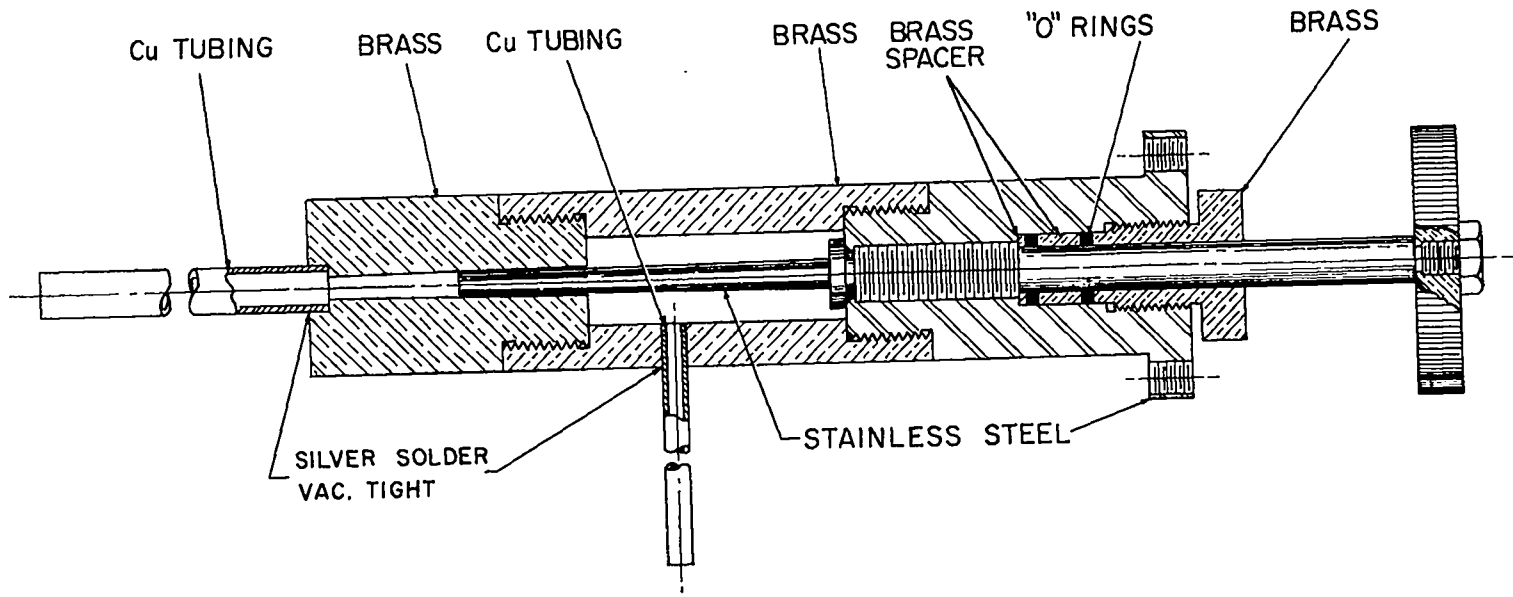

Fig. 4. Cross section of variable leak valve.

After polishing, the mounted specimen was placed on the gallium-tinned aluminum cathode within the etching chamber. Hot tap water was run through the cathode to melt the gallium and establish good contact between the specimen and the cathode. Then cold water was circulated to solidify the gallium and cool the specimen during bombardment. The chamber was evacuated to between 0.01 and 0.02 micron, flushed several times with argon, and back-filled with argon to a pressure between 30 and 40 microns.

Potential was applied initially at 500 volts, and held at that voltage for about ten minutes in order to allow conditions to become stabilized within the chamber. Then, when conditions had become stable, as evidenced by steady indications of the voltmeter, ammeter, and pressure gauge, the voltage was increased in increments of 500 volts until a potential of 2500 volts had been attained. At this voltage, removal of metal atoms from the specimen was fairly rapid. The decision as to when the specimen had been etched sufficiently was made on the basis of visual examination during the runs. The total etching time required after attaining the maximum voltage necessary was about an hour, depending on the nature of the specimen. Alpha plutonium seemed to have a low sputtering rate, whereas beta and delta plutonium had somewhat higher rates of removal of metal atoms.

## DISCUSSION

During the initial runs with plutonium, metal was observed to be deposited on the chimney; however, no structural detail was seen on the specimen surface although the earlier runs with uranium had been successful. The major difficulties appeared to be: (1) occasional arcing from the back of the anode to the cathode, but outside the focusing chimney, thus limiting the potential that could be applied to the specimen; (2) cathode glow which covered the entire cathode area; (3) high specimen temperature; and (4) residual oxygen within the etching chamber. Visual examination during bombardment, and microexamination after the runs, disclosed the presence of a dark non-metallic film over the entire specimen surface. In one run, the film was observed to crack and pop off, leaving a bright, clean surface beneath. One or two of the specimens had small areas which appeared to be etched.\*

Elimination of extraneous arcing was accomplished by insulating some of the exposed metallic surfaces. The back of the anode was wrapped with glass wool as a temporary measure until a Teflon shield could be fabricated. The cathode was partially shielded with a 4 in. diameter glass petri dish that had a 1 in. diameter hole in its center to accommodate the specimen. These measures eliminated the arcing; however, the discharge still covered the entire 1 in. diameter cathode area. According to J. J. Thompson,<sup>9</sup> an "abnormal" discharge, or a discharge

---

\* See Appendix for details of individual runs.



that covers the entire cathode surface, is not conducive to cathodic disintegration. On the other hand, a "normal" discharge has been observed to cause removal of cathode metal atoms. It appeared that the entire surface of the cathode, except for that portion on which the specimen rested, would need to be insulated in order to obtain a "normal" discharge with plutonium as the specimen and aluminum as the cathode. When the cathode was thus entirely shielded by an insulator, a "normal" discharge, i.e., a glow which covered only the top surface but not the sides of the specimen, was observed. The glass petri dish was later replaced with a Teflon insulator having a smaller center hole cut to accommodate the specimen more closely. Insulating the cathode in this manner resulted in better etching of the specimen. It became apparent that a better understanding of potential distribution and the mechanism of metal removal would be needed to further improve the shielding, so it was decided to determine first the general effects of the method, i.e., to actually try to achieve well delineated structures, even if they occurred only on small portions of the specimen, before making any further changes in the equipment.

Because many of the alloys of interest contain alpha plutonium, which transforms to the beta phase at 122°C, it was necessary to keep the surface of the specimen below that temperature during the bombardment in order to observe the original structure. The actual temperature attained on the surface of a specimen of alpha plutonium under bombardment was measured by means of a chromel-alumel thermocouple spot-welded

to the mechanically polished surface of the specimen. In the first run, the specimen was partially suspended by the thermocouple wires and therefore was not in close contact with the water-cooled cathode. The maximum specimen temperature was 160°C. In the second run, made with the specimen resting flatly on the cathode, the maximum temperature was only slightly lower, 150°C. Figures 5 and 6 are time-temperature plots of data taken during these two runs. In both runs, the specimens were discolored badly, becoming first purple, then blue, and finally a non-metallic gray.

It was obvious both from the data and from observing the surface discoloration that better coupling between the specimen and water-cooled cathode would be needed if alpha plutonium were to be etched. A low-melting metal, gallium, was then successfully used as a coupling medium to improve thermal conductivity and thus reduce the specimen temperature. A small piece of gallium was placed on the surface of the aluminum cathode and was melted by running hot tap water through the central cavity of the cathode. The alpha plutonium specimen with the thermocouple attached was placed on the liquid gallium, cold water was circulated through the cathode, and the gallium was solidified. The specimen was then bombarded in the normal manner to obtain the data that are plotted in Fig. 7. The gallium coupling reduced the maximum specimen temperature to about 60°C, well below the alpha-to-beta plutonium transformation temperature. It is of interest to note in Fig. 7 that the temperature change appears to be indirectly related to the gas pressure

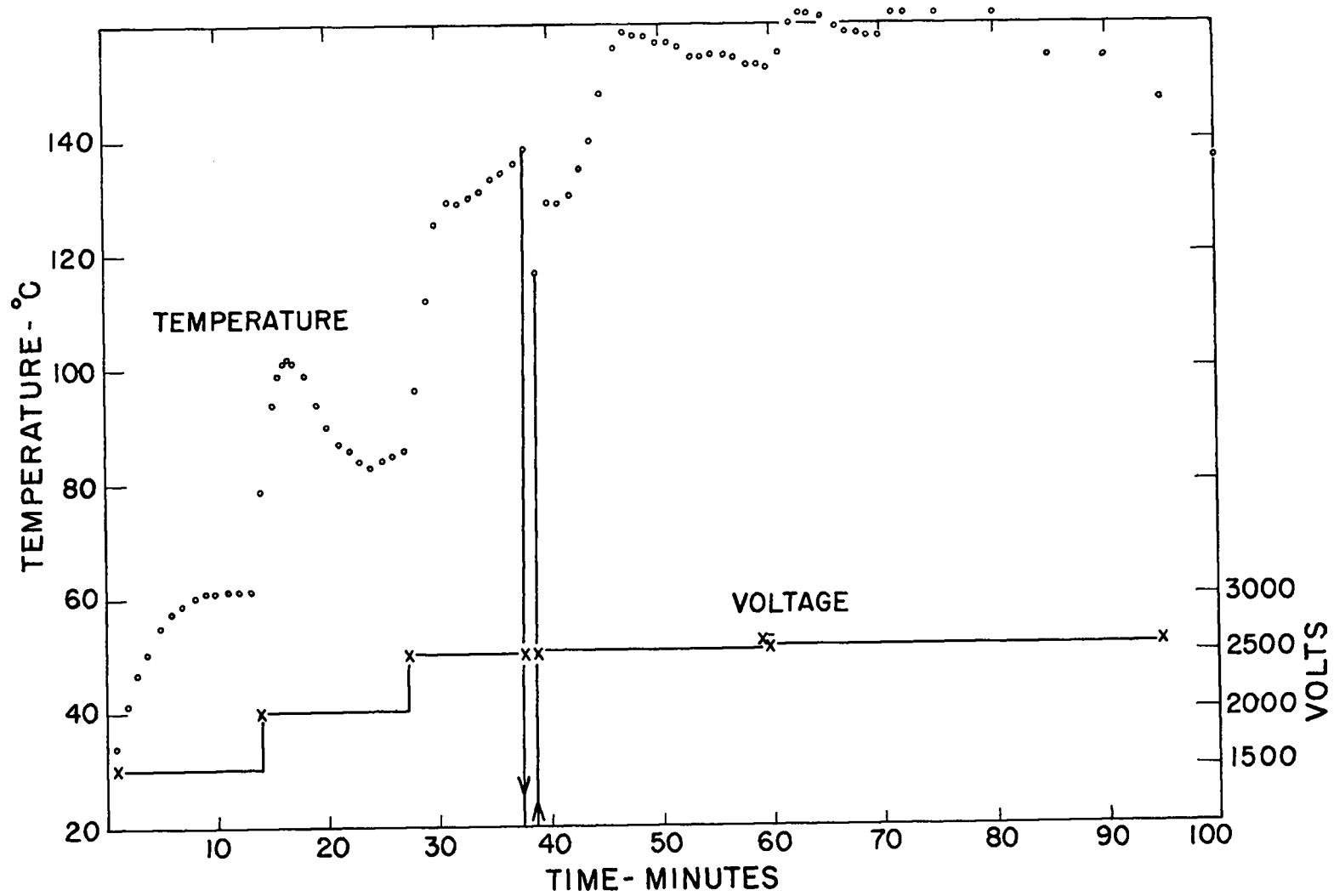

Fig. 5. Graph of temperature and voltage versus time for an alpha plutonium specimen suspended from thermocouple wires above the surface of the water-cooled cathode.

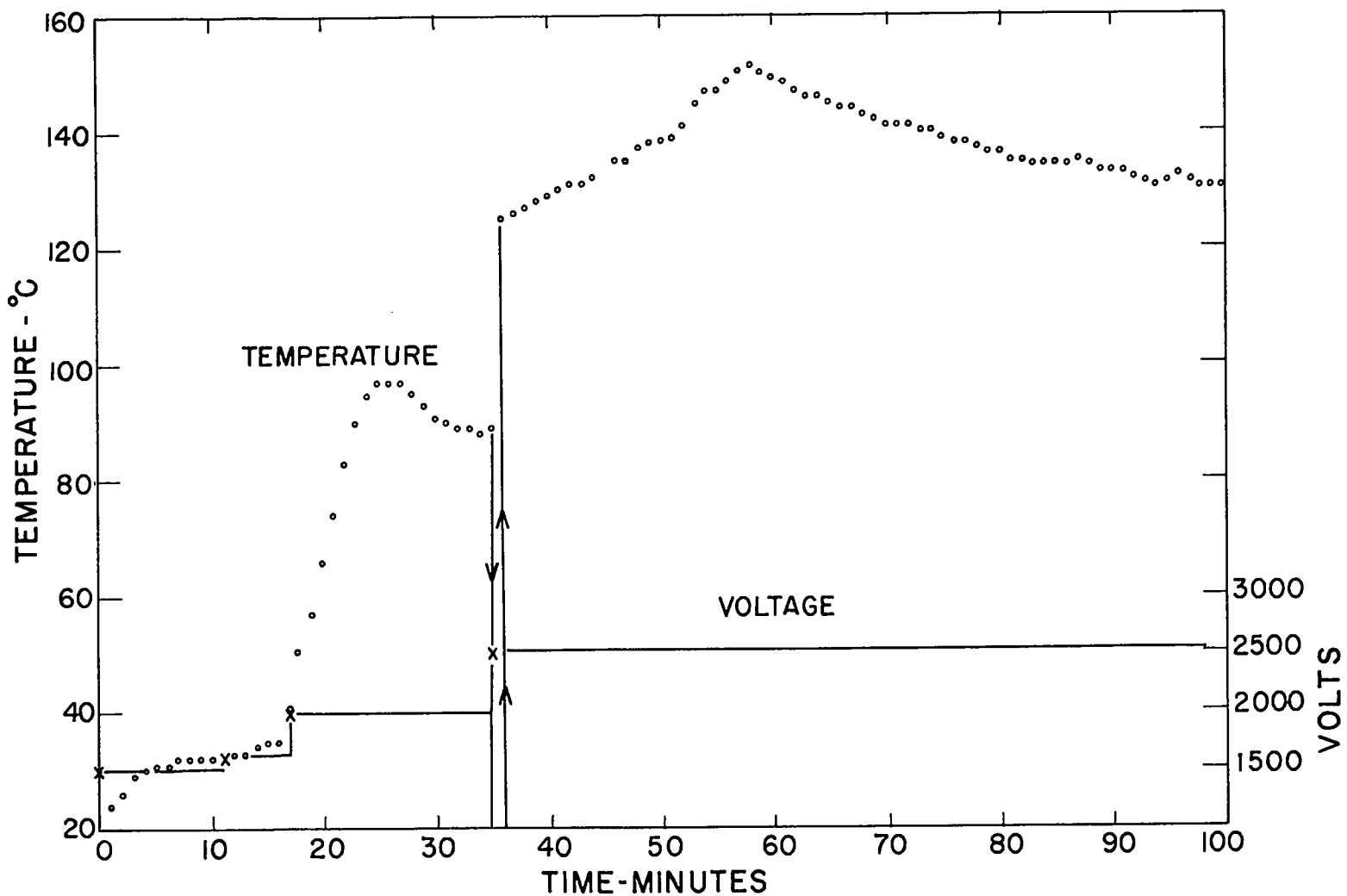

Fig. 6. Graph of temperature and voltage versus time for an alpha plutonium specimen in contact with the surface of the water-cooled cathode.

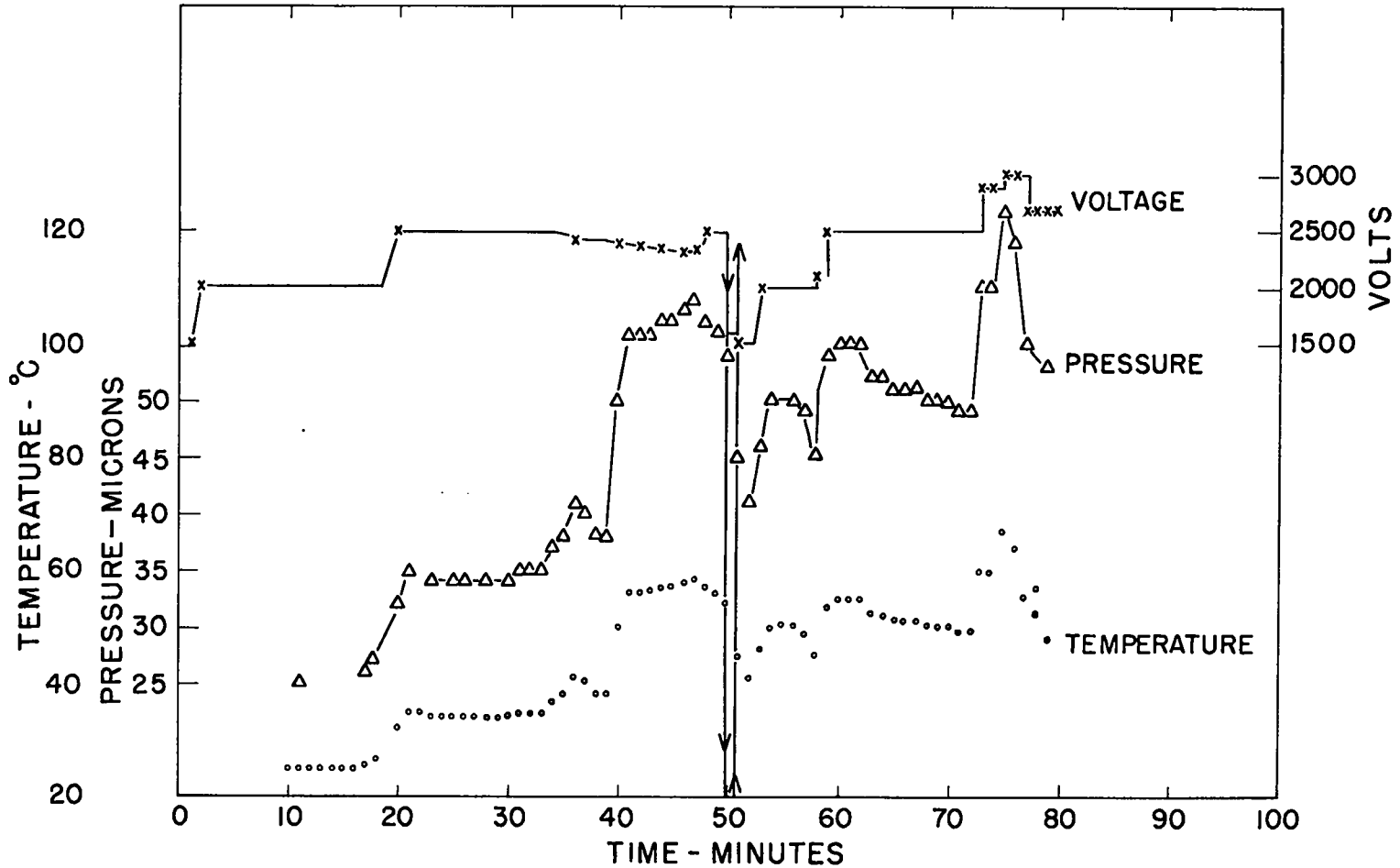

Fig. 7. Graph of temperature, pressure, and voltage versus time for an alpha plutonium specimen with gallium used as the coupling medium between the specimen and water-cooled cathode.

when there is adequate cooling. When the pressure is held constant and the cooling is inadequate, Figs. 5 and 6, the temperature increases with increased voltage but then, after reaching a peak, decreases to a relatively constant intermediate temperature. Also, it is to be noted that decreasing the voltage to zero, allowing the specimen to cool to room temperature, and then applying a potential of 2500 volts caused a very rapid rise of temperature to a value well above that measured for the same voltage achieved by 500 volt increments.

The problem of oxygen in the system seemed to be overcome by initially evacuating the system to 0.01 to 0.02 micron, flushing several times with argon, and keeping all surfaces within the chamber as clean as possible.

With the equipment and procedure modified as described above, it was possible to etch a variety of specimens. The specimen surface temperature studies had shown that a fluctuation of chamber conditions occurred with each increase in voltage. Since large variations in temperature were undesirable, it was necessary to increase the voltage gradually from the start of ionization at about 500 volts, by 500 volt increments, in order to minimize the temperature fluctuations. From the experience gained in a series of runs with alpha plutonium, zirconium-stabilized beta, and aluminum-stabilized delta plutonium, the optimum etching conditions described in the procedure were established.

Concurrently with these experiments, a hot cell was being designed to accommodate specimens of pile-irradiated plutonium fuel alloys. When

the etching of plutonium by cathodic bombardment was found to be practical, it was decided to use this technique in the cell in order to eliminate the necessity for liquid etchants and to provide a method that would have promise of simultaneously etching alloy and container.

The remote handling of various sizes and shapes of specimens in a hot cell requires a mount that is simple to handle and that will facilitate mechanical polishing, but that will not adversely affect the specimen surface during bombardment. For this purpose an aluminum cylinder 1-1/4 in. in diameter by 1/2 in. thick was machined to have a recess of appropriate depth to contain a specimen. The recessed surface was wet with gallium and the specimen was placed on the gallium. The recess was then filled with a polymerized liquid casting resin to hold the specimen in place and to cover the gallium, which has a very high sputtering rate. After the mechanical polishing, the mounted specimen was placed on the gallium-tinned aluminum cathode and the discharge was initiated as described. The specimen as well as the mount was observed to glow under bombardment. Examination after the usual etching period showed that the outside edges of the aluminum mount and the interior portions of the specimen were etched, and that the Teflon insulator was covered with a thin film of aluminum. In an attempt to enlarge the etched area a second Teflon shield with a central hole just large enough to expose the specimen was cut to fit the chamber. After a trial with the second insulator in place, examination of the specimen indicated that very little benefit was derived from the attempt to provide more effective shielding.

Possibly, the smallness of the etched area may result because, during bombardment, the insulating material--glass, plastic, or Teflon--picks up a charge that repels the positive argon ions. Further work will be directed toward explaining the smallness of the etched area.

## RESULTS

The obtaining of a partially etched surface on a plutonium alloy specimen indicated that cathodic etching of plutonium allotropes and alloys is feasible. Although the structures that were observed are not ideal, probably due in part to inadequate understanding of the behavior of the electrical discharge, the apparatus and procedure described above eventually produced well defined microstructures for portions of specimens of plutonium allotropes, several two-phase alloys, and a plutonium alloy in a tantalum container.

A few examples of clean, well delineated microstructures obtained by cathodic bombardment are presented in Figs. 8 through 17. For the most part these represent selected areas of a specimen surface. For comparison, photomicrographs of the same or similar specimens electrochemically etched are also included. Of particular interest are the apparent grain structure developed by cathodic etching of alpha plutonium and the detail shown in both phases of the alloy containing 50 a/o (atomic per cent) cerium. The structure observed on the alpha metal had never before been revealed by electrochemical etching, nor had this method revealed any detail of the primary phase of the cerium alloy.

(Text continues on page 33)



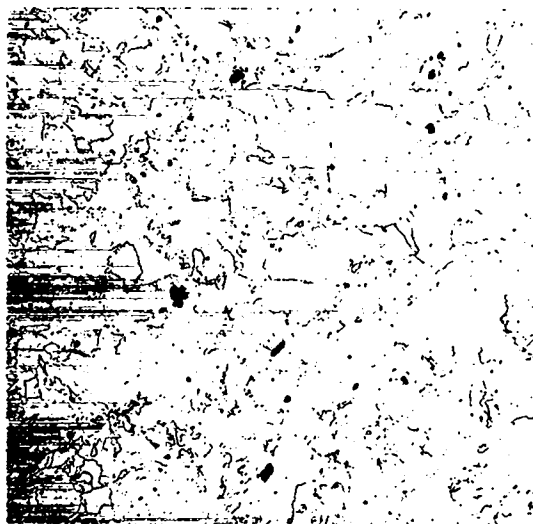

100X

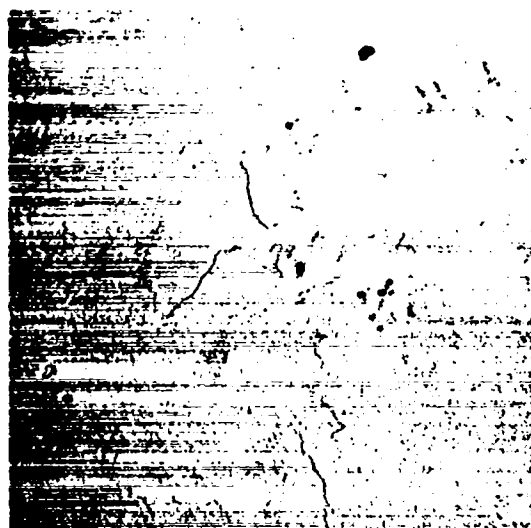

500X



250X



250X, polarized light

Fig. 8. Zone-melted, high purity alpha plutonium, etched by cathodic bombardment.

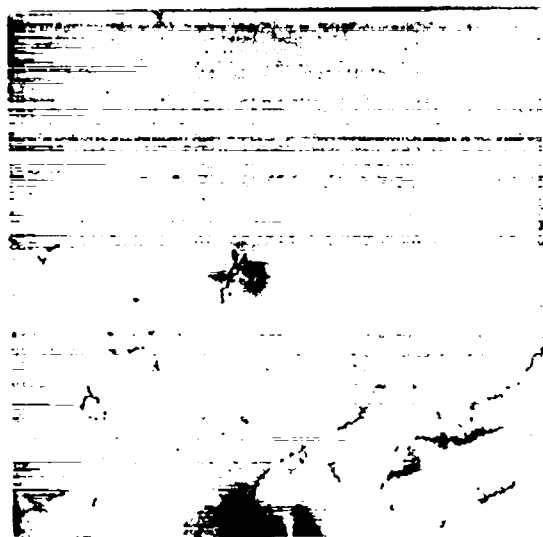

100X

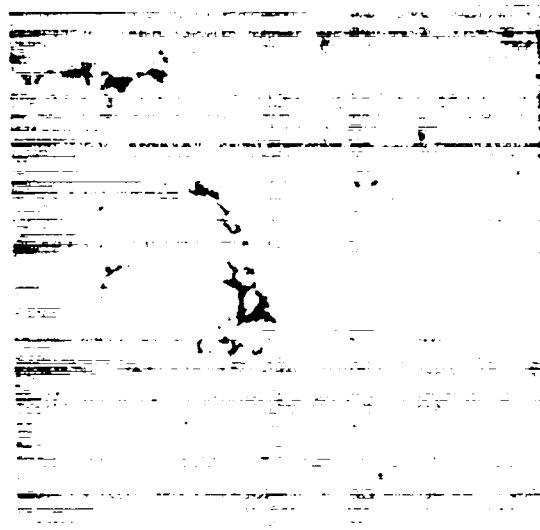

500X

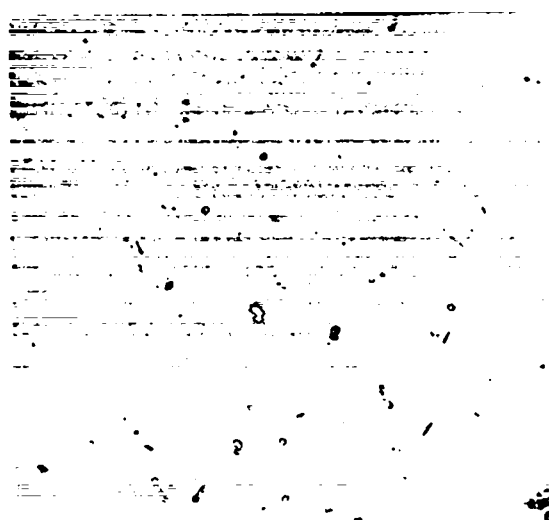

250X

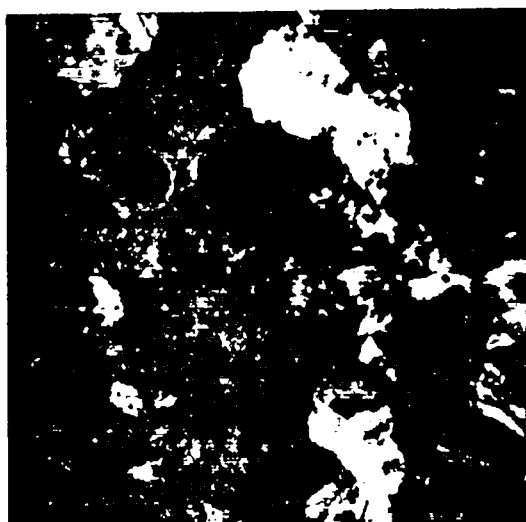

250X, polarized light

Fig. 9. Zone-melted, high purity alpha plutonium, electrochemically etched 90 sec at 8 volts in 7 parts tetraphosphoric acid, 36 parts water, 57 parts 2-ethoxyethanol.

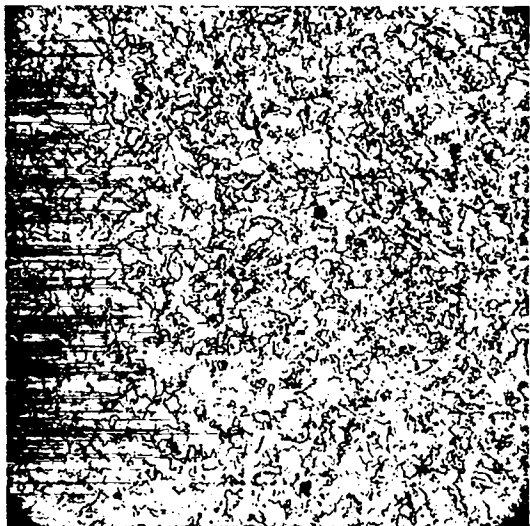

100X



1000X

5 a/o titanium alloy, cathodically etched.

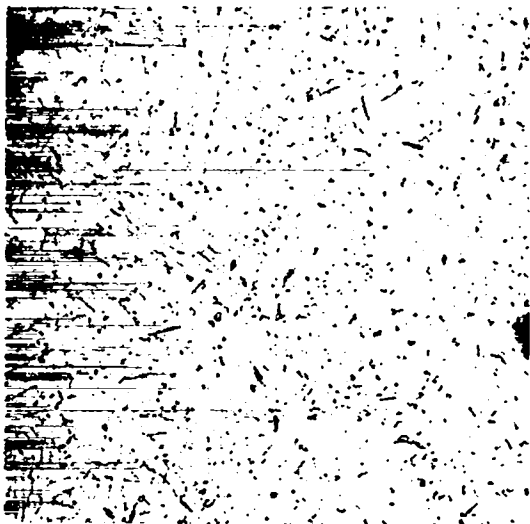

100X

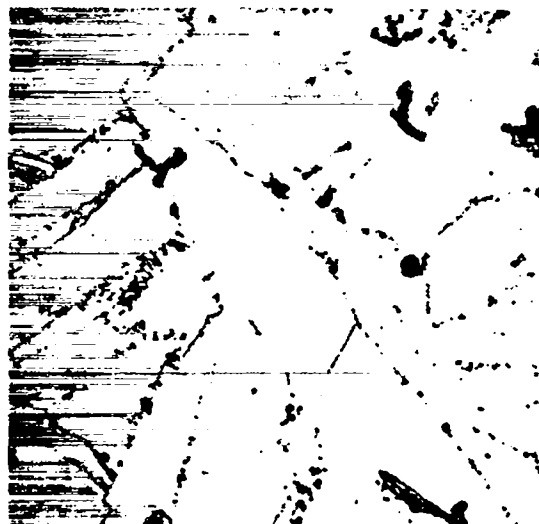

1000X

5 a/o titanium alloy, electrochemically etched.

Fig. 10. Titanium-stabilized beta plutonium. Top specimen was slowly cooled and etched by cathodic bombardment. Bottom specimen was as cast, electrochemically etched 15 sec at 8 volts in 7 parts tetraphosphoric acid, 36 parts water, 57 parts 2-ethoxyethanol.



100X



500X

6.6 a/o zirconium alloy, cathodically etched.

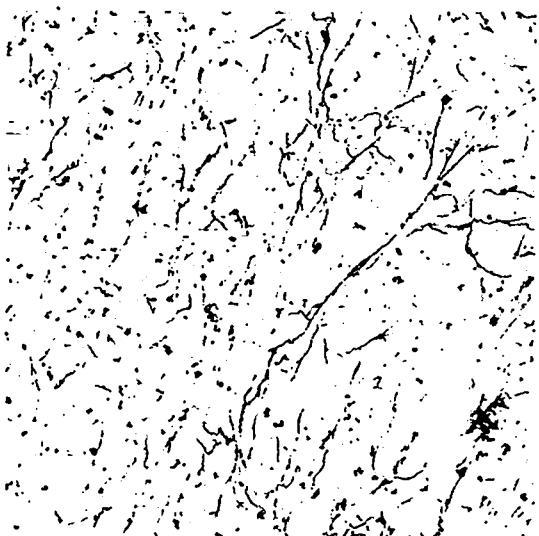

100X



500X

5 a/o zirconium alloy, electrochemically etched.

Fig. 11. Zirconium-stabilized beta plutonium. Top specimen was cold rolled and etched by cathodic bombardment. Bottom specimen was as cast, electrochemically etched 15 sec at 7 volts in 7 parts tetraphosphoric acid, 36 parts water, 57 parts 2-ethoxyethanol.

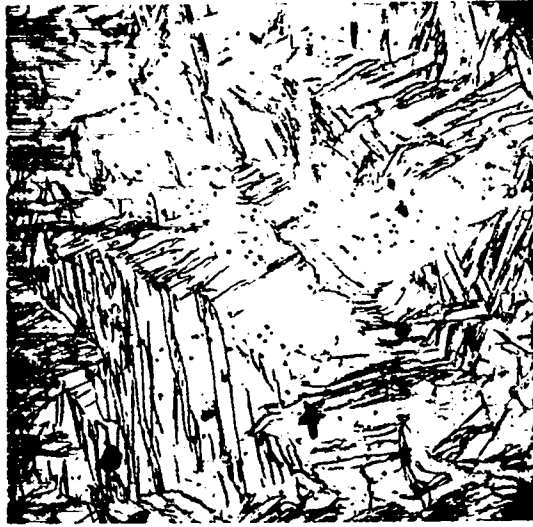

100X

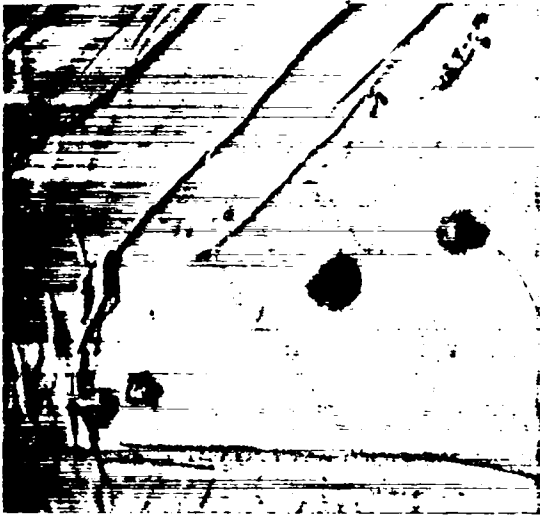

1600X

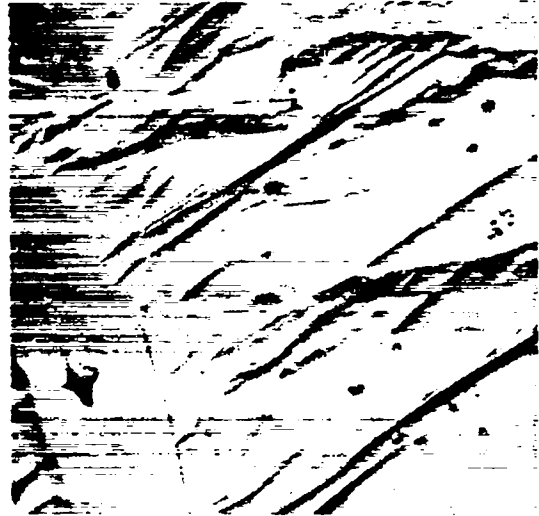

1600X

Fig. 12. A 10 a/o uranium-plutonium alloy, as cast, cathodically etched. Identified by X-ray diffraction as alpha plutonium plus eta solid solution.

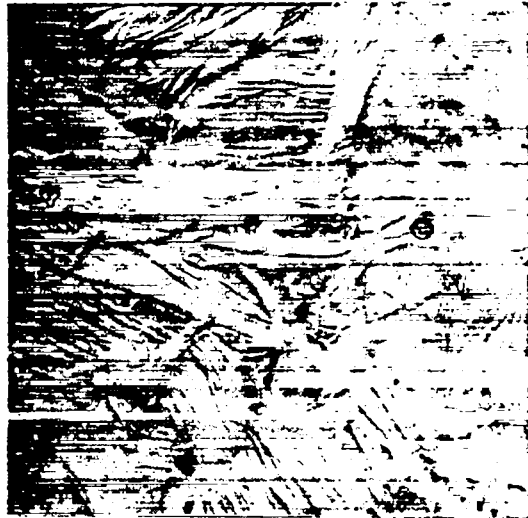

10 a/o uranium alloy, as cast. 500X.



100X

500X, polarized light

10 a/o uranium alloy, heat-treated.

Fig. 13. Uranium-stabilized beta plutonium solid solution. Top specimen was as-cast material identified by X-ray diffraction as alpha plus beta plutonium solid solution. Electrochemically etched 4 min at 6 volts in 8 parts orthophosphoric acid, 5 parts ethanol, 5 parts glycerine. Bottom specimen was heat-treated at 275°C and quenched to retain beta plutonium. Electrochemically etched 6 min at 6 volts in 8 parts orthophosphoric acid, 5 parts ethanol, 5 parts glycerine.

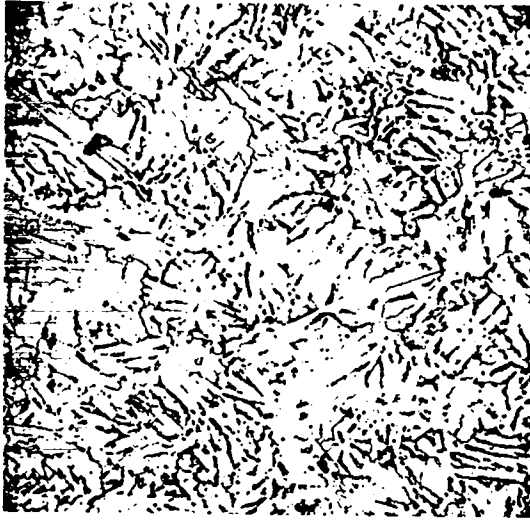

100X

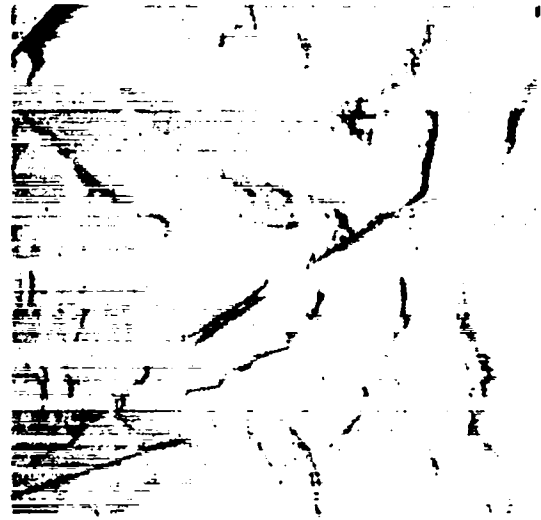

500X

As cast, etched by cathodic bombardment.

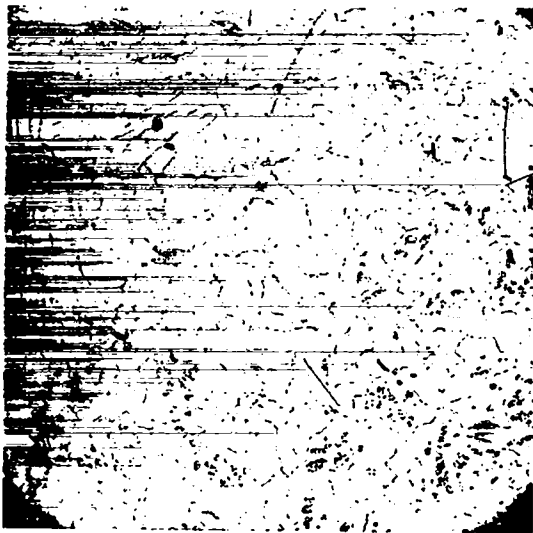

100X

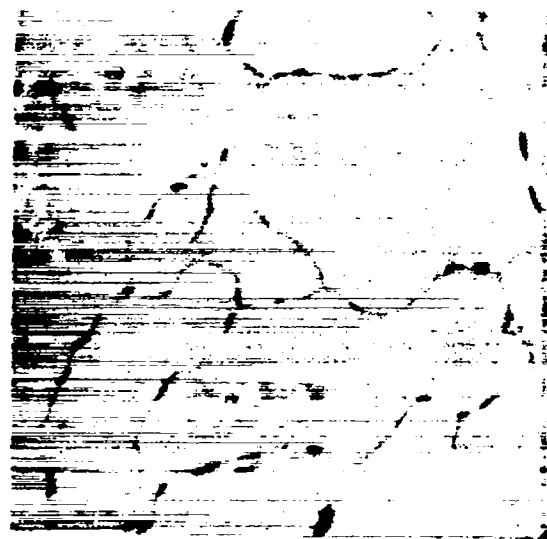

500X

Heat-treated, electrochemically etched.

Fig. 14. Delta plutonium alloy stabilized with 8 a/o aluminum. Bottom specimen was heat-treated at 485°C. for 96 hr and electrochemically etched for 1 min at 16 volts in 7 parts tetraphosphoric acid, 36 parts water, 57 parts 2-ethoxyethanol.

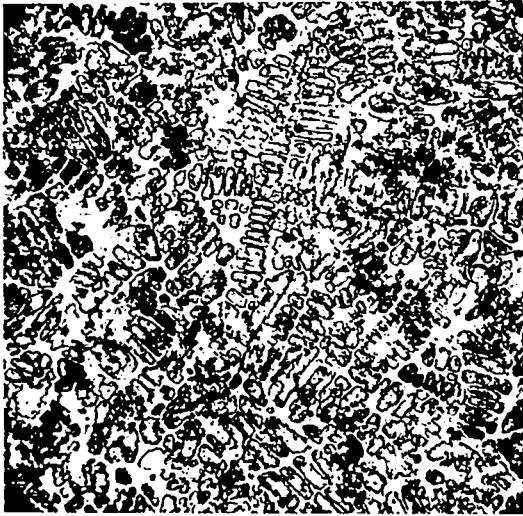

100X

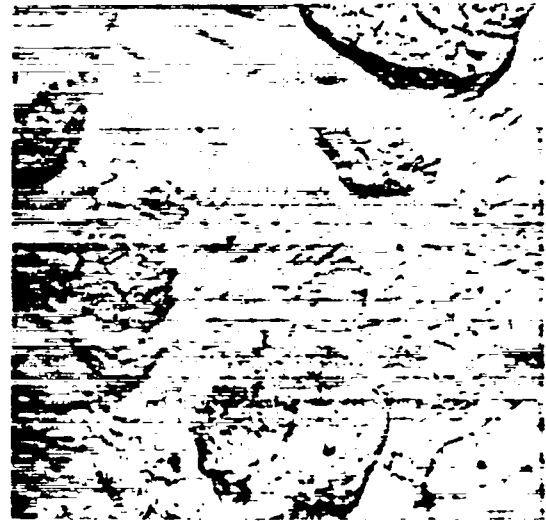

1000X

As cast, etched by cathodic bombardment.

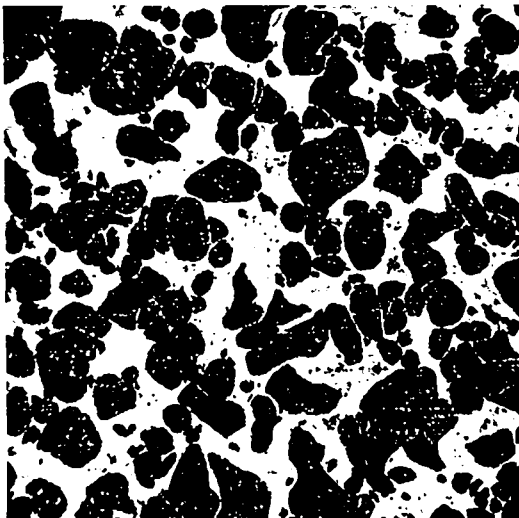

100X

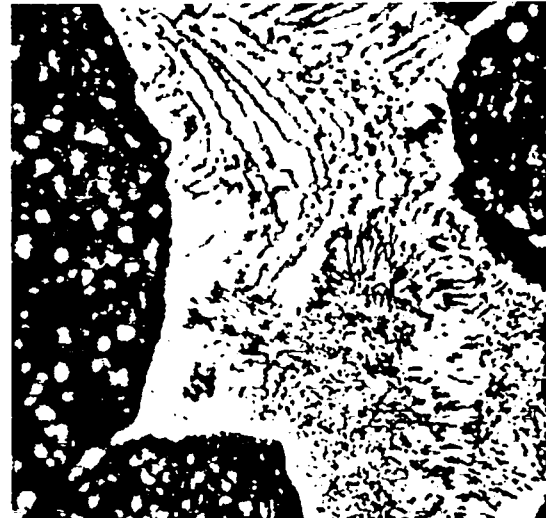

1000X

After quenching, electrochemically etched.

Fig. 15. 50 a/o cerium in plutonium. Bottom views show same specimen as at top after quenching from 633°C. Electrochemically etched 30 sec at 8 volts plus 5 sec at 24 volts in 7 parts tetraphosphoric acid, 36 parts water, 57 parts 2-ethoxyethanol.



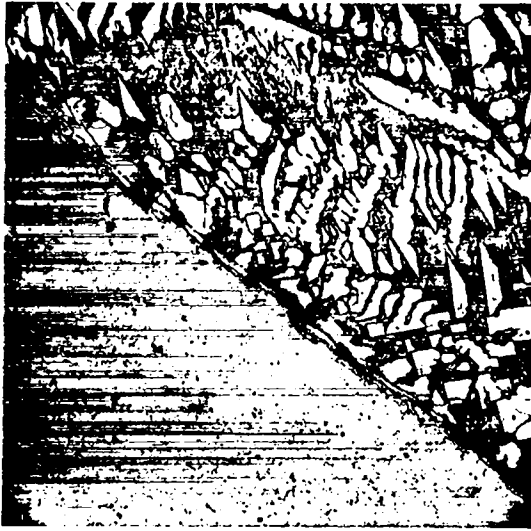

100X

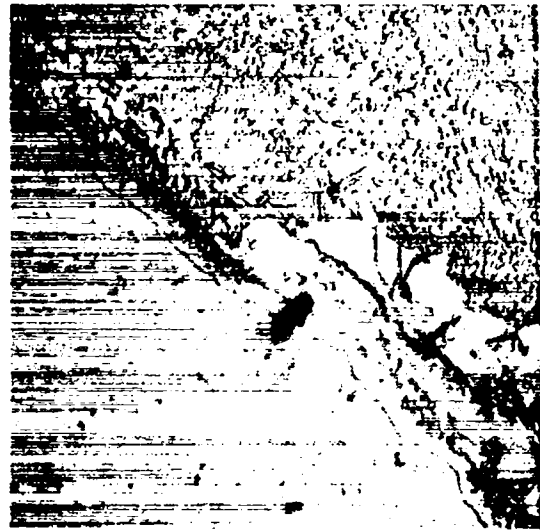

500X

Etched by cathodic bombardment.



100X

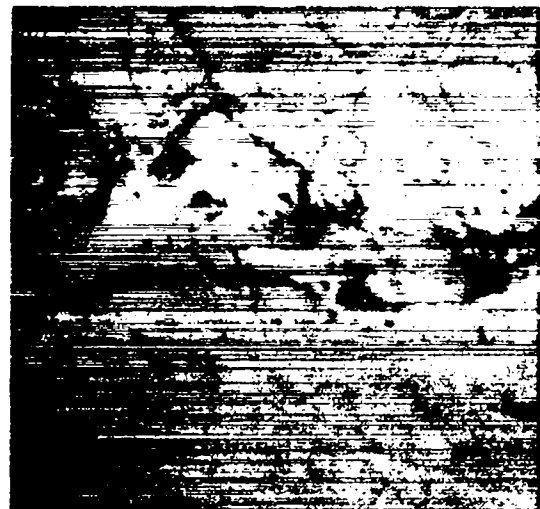

500X

As polished.

Fig. 16. 20 a/o silicon in plutonium and tantalum container after a static test. Bottom views show same specimen as above photographed in as-polished condition. Electrochemical etching produces an oxide film on the plutonium-rich metal.

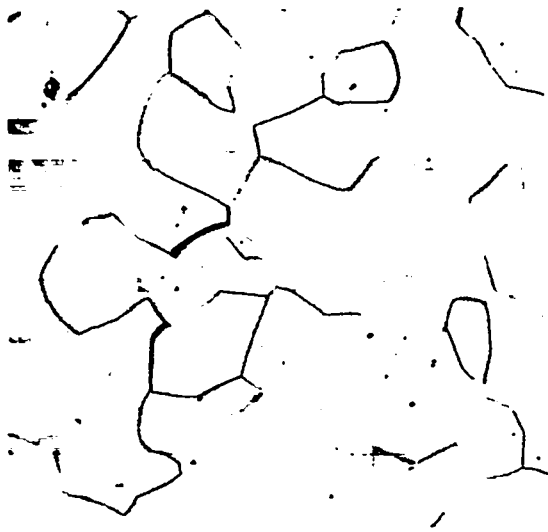

500X

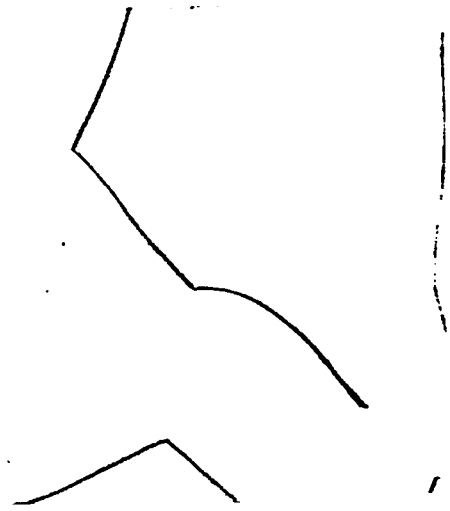

1000X

Etched by cathodic bombardment.



500X



1000X

Electrochemically etched.

Fig. 17. Tantalum metal etched by cathodic bombardment and electrochemically etched 3 min at 0.6 volt in 10 parts hydrofluoric acid, 90 parts sulphuric acid.

## CONCLUSION

Cathodic bombardment has resulted in the etching of plutonium, but it is not a cure-all. It is, however, a particularly useful technique where (1) remote handling of specimens is required, (2) conventional methods fail, or (3) specific features such as inclusions, phase demarcation, grain size, deformation, or the like are of interest.

A new unit is being built which will contain modifications based on the experience gained with the above described equipment. It is hoped that use of the new apparatus will give rise to better understanding of the mechanisms involved in metal etching and of the nature and control of the electrical discharge and will result in the development of a reliable etching method.

#### REFERENCES

1. Imlah, K., and Cramer, E. M., "The Metallographic Preparation of Plutonium and Its Alloys at Los Alamos", paper presented at the 12th Annual Meeting of the AEC Metallographic Group at St. Louis on February 26, 1958.
2. Cramer, E. M., and Schonfeld, F. W., "The Techniques for the Metallography of Plutonium", Paper 570, The Second International Conference on the Peaceful Uses of Atomic Energy, Geneva, 1958.
3. Smith, Cyril S., "Note on Cathodic Disintegration as a Method of Etching Specimens for Metallography", Journal of the Institute of Metals, Vol. 38 (1927), pp. 133-136.
4. Padden, T. R., and Cain, F., Jr., "A Modified Cathodic Vacuum Etching Procedure with Versatile Metallographic Application", Westinghouse Atomic Power Division Report WAPD-83, 1953.
5. Bierlein, T. K., "Cathodic Vacuum Etching of Uranium", Hanford Works Report HW-32676, 1954.
6. Imlah, K., "A Modified Method of Cathodic Etching for Adaptation to Remote Control Application", Atomic International Internal Memorandum, 1955.
7. Strong, John, Procedures in Experimental Physics, Prentice-Hall, Inc., New York, 1938, p. 163.
8. Schonfeld, F. W., Tate, R. E., and Maraman, W. J., "Distinctive Features of the Los Alamos Glove-box Design and Operational Procedures", Glove-box Symposium Paper No. 11, presented at the Atomic Energy Research Establishment, Harwell, U. K., February 19 to 21, 1957.
9. Thompson, J. J., and Thompson, G. P., Conduction of Electricity through Gases, Vol. II, 3rd edition, Cambridge University Press, London, 1933, Chap. VIII.

## Appendix

### EXPERIMENTAL DETAILS

The following information pertains to details of some of the runs that were made during the course of the investigation and which formed the basis for developing the procedure described in this report.

In several runs, a Lavite insulator on the cathode was found to be effective in focusing the discharge. This insulator was a flat disk having a center hole to accommodate the specimen, and two holes offset from the center to allow free access for evacuating the chamber and admitting argon.

An attempt was made to etch a 20 mil foil specimen of a plutonium alloy containing 6 w/o (weight per cent) hafnium under the following conditions:

Time (min)	Voltage (v)	Current (ma)	Pressure (microns)	Remarks
1	1000	0-2	55	
12	2000	0-2	45	
30	3000	2-4	50	Blue film on specimen

By reducing the pressure to 20 microns and holding the voltage constant at 3000 volts, the blue film was removed from a portion of the specimen. Examination of the specimen after the run revealed the presence of a small area of specimen surface that might have been etched had the run been continued.

A second run was made with the same specimen, but after about twenty minutes of exposure the specimen surface became dark gray, through a number of intermediate color changes, and remained dark for an additional forty minutes until the run was terminated. Apparently, oxidation of the specimen was rapid in the presence of both excessive heat and the residual oxygen in the system.

In order to eliminate the Lavite insulator as a possible source of oxygen in the system, it was decided to use a glass insulator. Consequently, a glass shield was made by grinding three holes in a 4 in. diameter petri dish. A 1 in. diameter center hole accommodated the specimen, and two 1/4 in. diameter holes provided an inlet port for argon and an evacuation outlet.

With the apparatus thus modified, an attempt was made to etch a plutonium alloy specimen containing 5 a/o titanium. Initially, considerable arcing from the anode to the cathode through the two 1/4 in. diameter holes in the petri dish indicated that little etching of the specimen was taking place. The chamber was then opened, the specimen removed, and the glass insulator rotated approximately 90° to move the 1/4 in. diameter holes as far as possible from the corresponding holes in the cathode. Also, small watch glasses, 1/2 in. diameter, were placed over the two holes in the glass insulator to further reduce the extraneous arcing. After mechanical polishing, the specimen was replaced in the chamber and the run was continued for about twenty minutes at 2000 volts, 3 to 4 milliamperes, and 50 microns of pressure. Some

arcing outside of the chimney from the top of the anode to the base plate was observed. The glow discharge was reddish in color, which indicated that oxygen was still present in the system. (A pure argon glow discharge is light blue.) After about twenty minutes the specimen appeared to have a matte surface, and the run was stopped. An oxide film had formed on the specimen surface. During microexamination this film was seen to crack and pop off, leaving a bright, clean surface beneath. Oxide reformed rapidly, however, and close observation of the surface was impossible because of the health hazard associated with the disintegration of the film. The reason for this rapid formation of oxide is not known. Possibly, it may have been facilitated by the specimen's being overheated during bombardment. Then, during the microscopic examination while the specimen was cooling to near room temperature, the different volume changes in the specimen and its oxide coat might have caused cracking of the oxide.

To further reduce the extraneous arcing, the anode was covered with aluminum foil, and its stem support was covered with glass wool.

The same specimen was repolished mechanically and placed in the chamber. After continuous evacuation of the system for 3 days the run was started.

Time (min)	Voltage (v)	Current (ma)	Pressure (microns)	Remarks
1	2000	-	20	
2	2500	-	20	
21	3000	-	30	
23	2900	1	30	
29	3000	1	30	
65	2000	1	35	No deposit on chimney
68	2500	1	40	
91	3000	1	40	
292	3000	1	40	Black deposit on chimney, one end of specimen dark

Evidently the additional insulation was effective, since no extraneous arcing outside the focusing chimney was observed during the run, and a good etch, as shown in Fig. 10, was obtained on a portion of the specimen.

Next, a plutonium alloy strip containing 5 a/o aluminum was mechanically polished and placed in the etching chamber. After the pressure in the chamber had been reduced to 0.02 micron, argon was backfilled to a pressure of 45 microns and the run was started.

Time (min)	Voltage (v)	Current (ma)	Pressure (microns)	Remarks
1	1500	0.5	45	
4	2000	4	45	
8	2000	3	45	
10	2000	3	45	Reddish glow in chamber



The power was turned off and the system was again evacuated to 0.02 micron and backfilled with argon to a pressure of 40 microns before continuing the run.

Time (min)	Voltage (v)	Current (ma)	Pressure (microns)	Remarks
49	1500	1	40	
50	2000	2	40	
59	2500	2.5	37	
69	2700	1	35	
110	2800	1	30	Etching started
121	2800	0.3	40	Glow covers 15% of specimen surface
131	3000	0.2	42	
166	3000	0.2	42	Power off

It was observed that the portion of the specimen near the argon inlet and the adjacent area of the cathode were cleaner than the rest of the specimen and cathode. A good etch had been obtained on the clean end of the specimen.

It was then decided to determine to what extent the specimen surface was heated during bombardment. A lead-bismuth cold-welded couple was used for the specimen. The couple consisted of two small plates, one of lead and one of bismuth, pressed together. After 4 minutes exposure to the discharge at 2000 volts and 60 microns pressure, a reaction was observed at the lead-bismuth interface. Since the lead-bismuth eutectic temperature is 124°C, it was assumed that the temperature of the couple was at least that high. This conclusion made it evident that better cooling of the specimen was needed.

Earlier experience with another cathodic etcher used to etch non-radioactive specimens had shown that a film of silicone oil between the cathode and specimen was effective in improving thermal contact and keeping the specimen cool. However, since it would be difficult to control movement of the oil on the flat cathode surface of the present equipment, it was decided to use a low-melting metal as the thermal coupling medium. Consequently, the area of the cathode where the specimen would rest was given a thin coating of gallium.

A zone-melted alpha plutonium specimen was mechanically polished and placed in the etching chamber on the gallium-tinned cathode. The system was evacuated to 0.05 micron and backfilled with argon to 33 microns.

Time (min)	Voltage (v)	Current (ma)	Pressure (microns)	Remarks
1	1500	-	33	
4	2000	1	33	
7	2500	1	33	
24	2600	1	35	Black deposit on chimney
48	2600	1	40	
73	2600	0.7	40	
115	Power off			

Microexamination of the specimen revealed a good etch, and the presence of apparent grain boundaries under bright-field illumination was confirmed by examination under polarized light. See Fig. 8.

Inadequate insulation of the cathode in the vicinity of the specimen appeared to result in back scattering and bending of the electrical

discharge. This extraneous arcing was further reduced by surrounding the specimen with several small watch glasses placed on the cathode.

An aluminum-stabilized delta-phase plutonium specimen was mechanically polished and placed in the chamber. The system was evacuated to 0.02 micron, and backfilled with argon to a pressure of 40 microns.

Time (min)	Voltage (v)	Current (ma)	Pressure (microns)	Remarks
1	1500	0.5	40	
48	2000	1	40	
60	2500	1.5	40	
145	2500	1.5	40	Power off

During this run the glow was well focused, and no discoloration of the specimen was observed. Microexamination of the specimen revealed a clean, well delineated microstructure.

The arrangement of insulating material within the etching chamber was not changed further for the rest of the runs described.

A run was made with a mechanically polished plutonium alloy specimen containing 6.6 a/o zirconium. After initial evacuation of the chamber to 0.05 micron and backfilling with argon to a pressure of 35 microns, etching was started. Microexamination of this specimen after the run showed that it had been etched uniformly. The cold-worked beta microstructure was well delineated, as shown in Fig. 11.

Time (min)	Voltage (v)	Current (ma)	Pressure (microns)
1	2500	1	35
24	2000	0.5	35
62	2500	1	35
64	2500	1.5	45
75	2600	1.5	45
86	Power turned off because of pressure increase in system. Chamber evacuated, backfilled, and run continued.		
86	2500	1.2	40
115	Power off		

The next specimen to be etched was an as-cast plutonium alloy containing 10 a/o uranium. After the chamber was evacuated to 0.02 micron and backfilled with argon to 40 microns, etching was started.

Time (min)	Voltage (v)	Current (ma)	Pressure (microns)	Remarks
1	1500	0.5	40	
29	2000	0.9	40	
57	2500	1.2	40	
120	2500	0.9	40	Power off

Microexamination showed that, although this two-phase specimen may have been slightly over-etched, the microstructure was clean and well-delineated. See Fig. 12.

It was then decided to investigate the thermal effects of the bombardment on the lead-bismuth cold-welded couple when gallium was used as the coupling medium between the specimen and cathode. After exposure of the specimen to the glow discharge at 2500 volts and 45 microns of

pressure, no evidence of melting was observed and it was concluded that the temperature of the couple must have been less than 124°C.

The experiment with the zone-melted alpha plutonium specimen mentioned above was then repeated under conditions similar to those used in the first run with this specimen.

Time (min)	Voltage (v)	Current (ma)	Pressure (microns)	Remarks
1	1500	-	25	
21	2000	1	37	
44	2500	2	45	
105	2500	0.5	37	
176	2500	0.9	36	Power off

Microexamination again revealed a good, uniform, well delineated microstructure.

Finally, an as-cast plutonium alloy specimen containing 50 a/o cerium was etched under conditions similar to those just described.

Time (min)	Voltage (v)	Current (ma)	Pressure (microns)	Remarks
1	1500	-	30	
22	2000	0.5	30	
23	2000	1	40	
28	2500	1.5	40	
47	2600	1	40	
130	2800	0.3	26	
133	2800	0.5	30	
138	2800	0.5	30	Power off

Microexamination of this etched specimen showed that it also had a good, uniform, well delineated microstructure. See Fig. 15.